

Product

Exploded View
Disassembly & Assembling



Shock absorber

5018 PDS 2003

Introduction	2
Exploded view	3
Disassembly shock absorber	4
Disassembly tube side	13
Disassembly MCC	33
Assembling MCC	39
Assembling Tube side	44
Disassembly piston-rod side	53
Disassembly adaptor DU-bush	63
Assembling adaptor DU-bush	67
Assembling piston-rod side	70
Assembling shock absorber	81
Bleeding	87
On pressure with nitrogen	92
Mounting spring	95
Adjustment	98



Introduction

General notice

Pay attention to the following notes, when you are working with WP suspension products as described in this workshop manual:

Always use clean and professional tools.
Regular you need next to the general equipment, the special tools of WP Suspension.
These tools with a unique "T" number (available at WP Suspension) protect you from damaging the parts.

Always use aluminium protector-plates, when clamping our products or parts in the vice.

Always replace damaged or worn parts.

Clean all parts before assembling.

Caution:

Many times it is necessary to assemble parts with T131, T132 and T163.

These parts must dry for at least four hours!!

Disassembly Shock absorber



Take note of the rebound (REB) position. Fully closed is turning the adjustment screw (“+”) clockwise.



MCC

MCC = Mono Compression Control

Take note of the compression (COM) position. Fully closed is turning the adjustment screw (“+”) clockwise.



DCC

DCC = Dual Compression Control

Take note of the compression Low-Speed position. Fully closed is turning the adjustment screw clockwise.



DCC

Take note of the compression High-Speed position.
Fully closed is turning the hexagonal (size 17) screw clockwise.

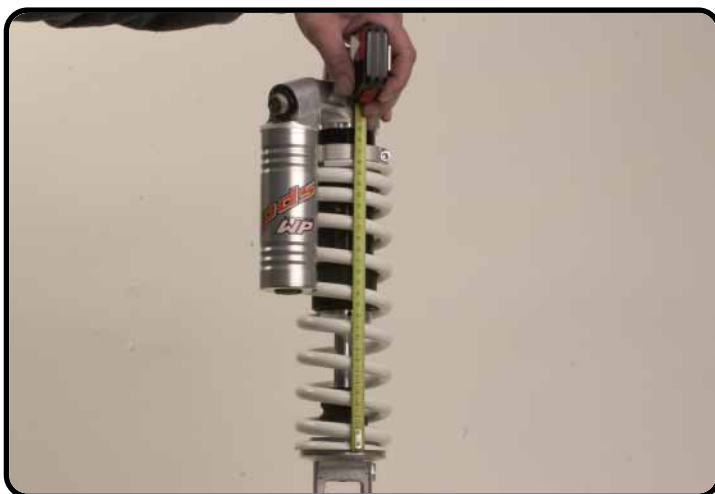

Measure the length of the spring.
Spring preload.



Unscrew the Allen bolt (size 4).



Release the spring preload with open spanner T106.



Screw the screw retainer against the lock retainer.



Disassemble the spring retainer and springing.



Remove the washer.



Remove the spring.
Pay attention to the assembling
direction!!!



Remove the second washer.



Spring with washers, spring retainer and springring.



Disassemble the rubber cap.



Unscrew slowly the nitrogen plug (size 4) to release the pressure.



Nitrogen plug with O-ring.



Tap the cap from the tube.



1. Place disassembling bush T1216 on the adaptor DU-bush.



2.



Push the adaptor DU-bush downwards.



Disassemble the springing out of the tube.



Springing.



Pull carefully but firmly the piston-rod "complete" out of the tube.



Push with depth-stop T107S the separation piston downwards.

Disassembly tube-side

Drain the oil out the tube.



Clamp the tube side in the vice.



Remove the springring out of the groove and slide it a little bit downwards.





Slide the guiding bush downwards.



Remove the upper springing.

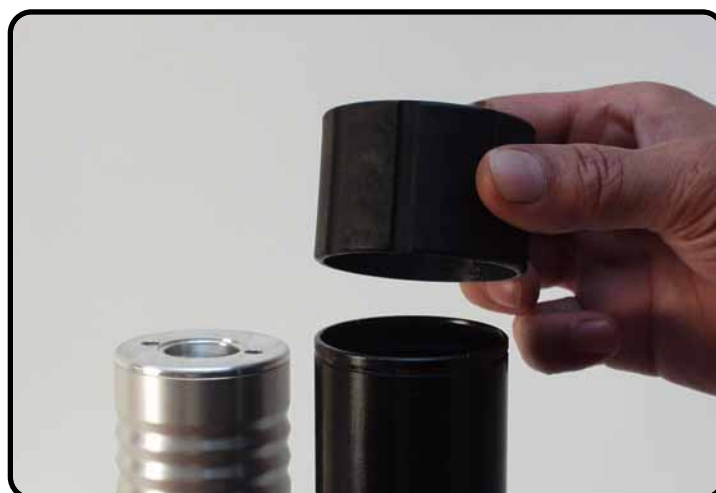

Remove the guiding bush.
Pay attention to the assembling
direction!!!



Remove the springring.



Spring guiding bush with the two springrings.



Turn the screw-retainer of the tube.



Screw-retainer with the Allen bolt.



Unscrew the screw-cap of the MCC
(size 24)
(DCC also size 24)



Remove the screw-cap.



Remove the washer inside the screw-
cap, or on top of the spring inside the
bottom.



Remove the spring.



Pull the damping holder "cpl" out of the bottom.



Srew-cap with adjustment needle, spring and the MCC damping holder "cpl".



Heat the lock retainer.

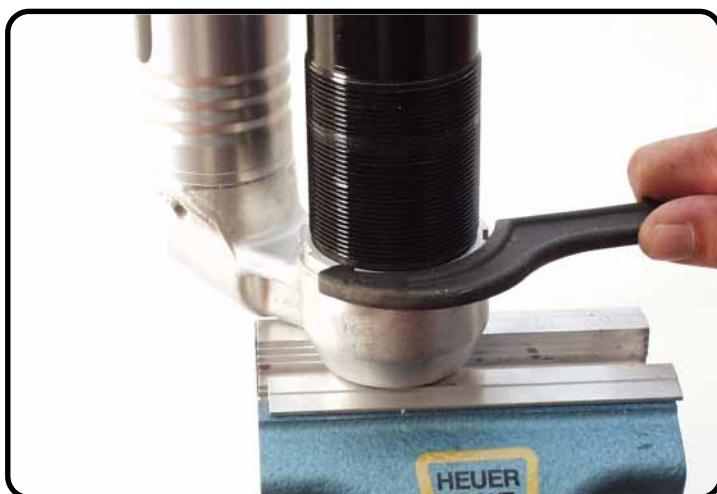

Unscrew the lock retainer with open spanner T1233.



Screw the lock retainer of the bottom.



Heat the bottom near the tube.



Use slide-spanner T146 with bush T1201.



Unscrew the tube.



Screw the tube out of the bottom.



Screw the lock retainer of the tube.



Tube with lock retainer.



Disassemble the O-ring out of the groove inside the bottom.



Place dis- / assembling tool T145S on top of the screw-cap

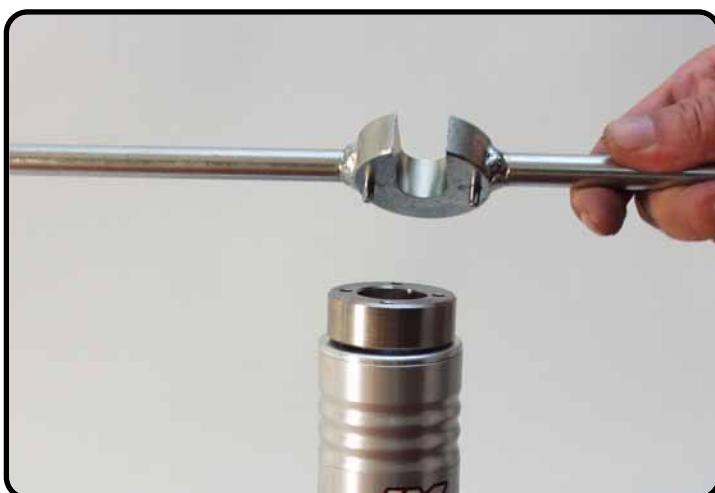

Place pin spanner T125S onto T145S.



Heat the reservoir near the bottom.



Unscrew the screw-cap.



Turn the reservoir from the bottom.



Remove the O-ring.



Bottom "cpl" with both O-rings.



Pay attention to the assembling direction!!!
Push the separation piston out of the reservoir.



Separation piston.

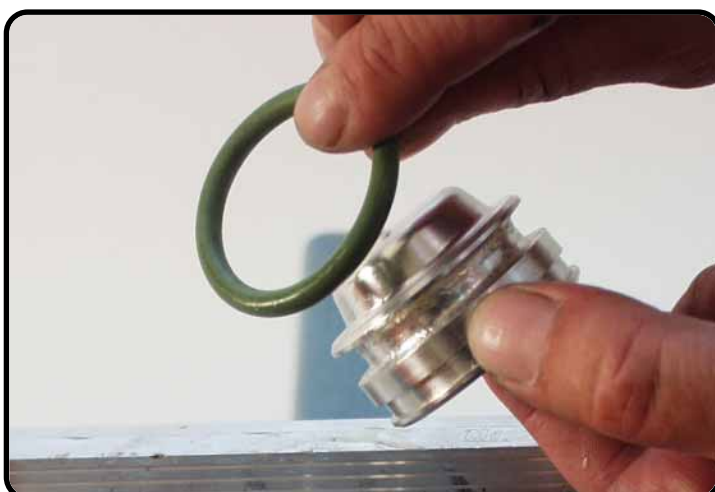

Disassemble the O-ring.

Workshop manual

5018 PDS 2003

Product

Exploded View

Disassembly & Assembling



Separation piston, piston ring and O-ring.



Clamp the bottom in the vice.



Use disassembling tool T120 for disassembling the adaptor bushes.

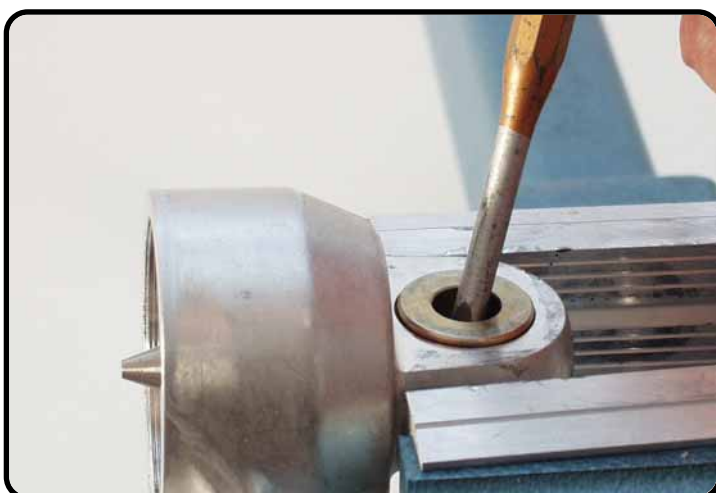

Tap the adaptor bush out of the heim-joint.

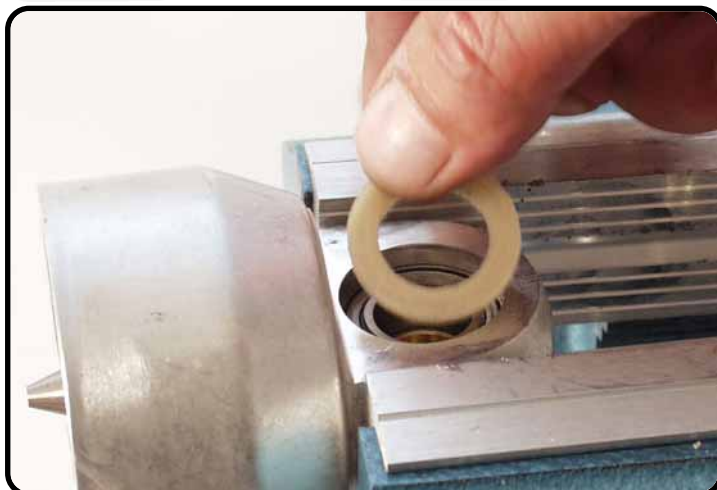

Remove the seal.

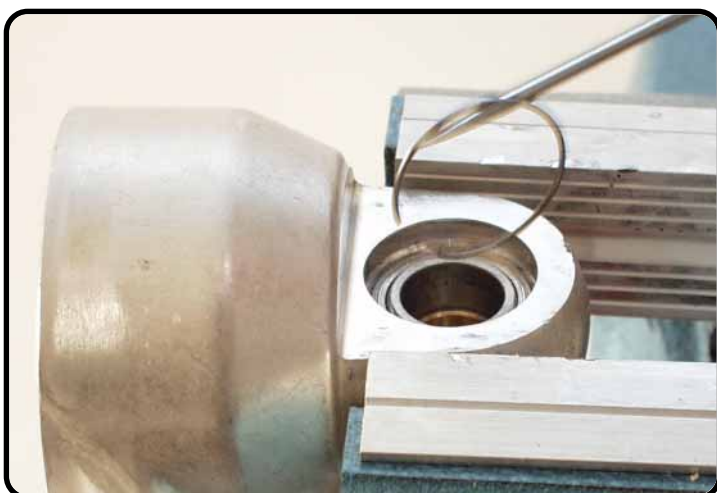

Disassemble the springing.

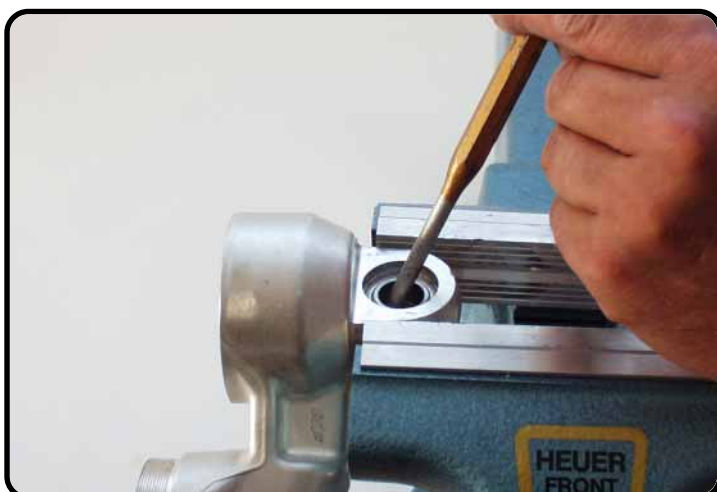

Tap the other adaptor bush out of the heim-joint.



Use Dis- / assembling tool T1207S for disassembling the heim-joint.

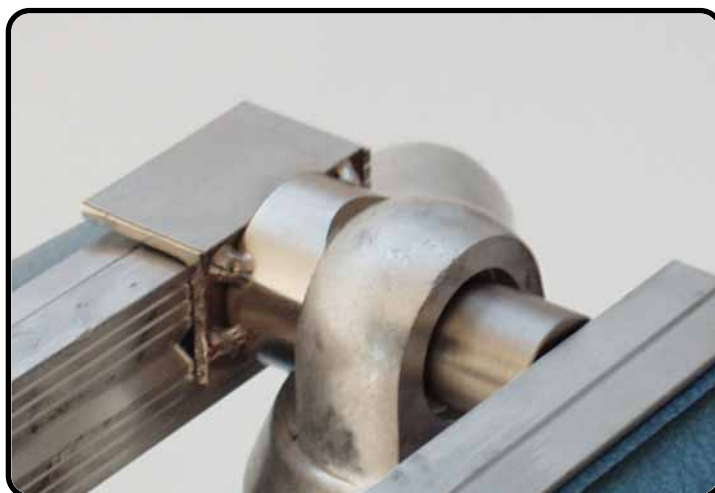

Press the heim-joint out of the bottom at the side were the springing is removed.



Adaptor bushes, seals, springrings and heim-joint.



Replace one springing.



Assemble the heim-joint with the bevelled edge into the direction of the bottom with assembling tool T1206.

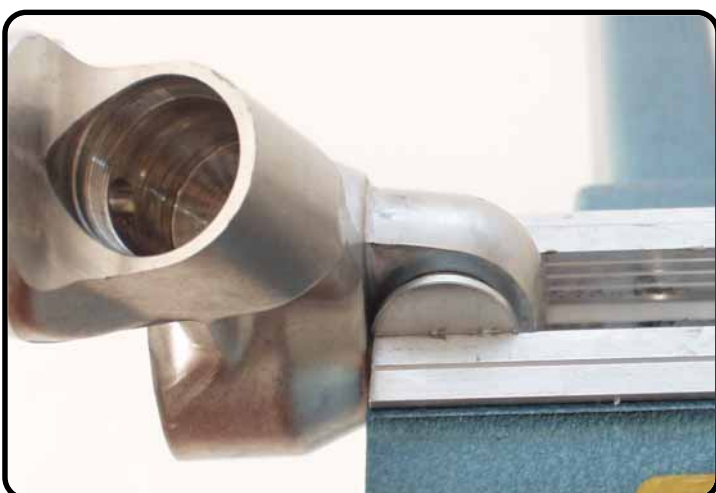

Press the heim-joint into the bottom with support of the vice.



Press with T1207(A) the heim-joint against the springring.



Assemble the springring into the groove.

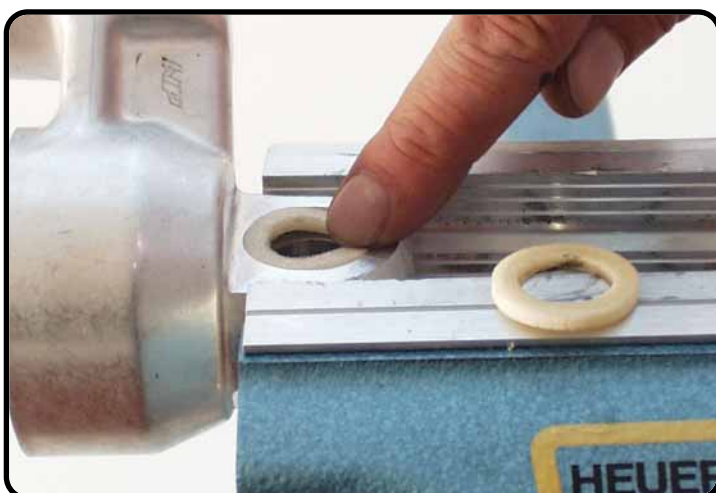

Replace the seals.



1. Assemble the adaptor bushes with support of T1206.



2.

Disassembly MCC

There is a separated workshop manual for the DCC.

Damping holder MCC.



Remove the disk.
Pay attention to the assembling direction!!!

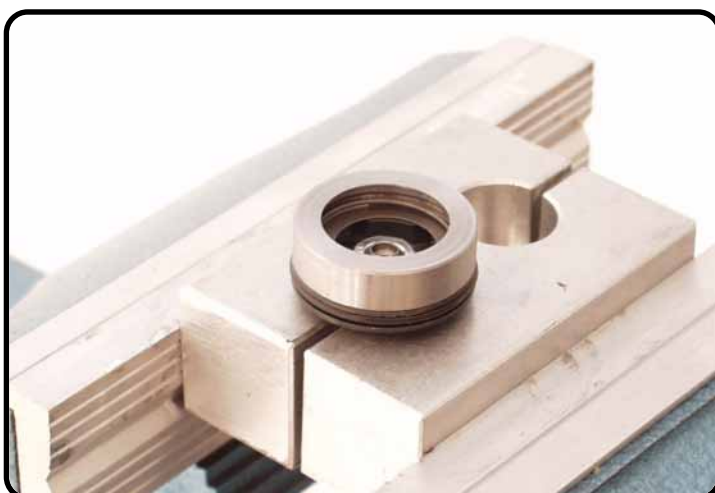

Clamp the damping holder with clamping block T1202S. **Not too tight!**

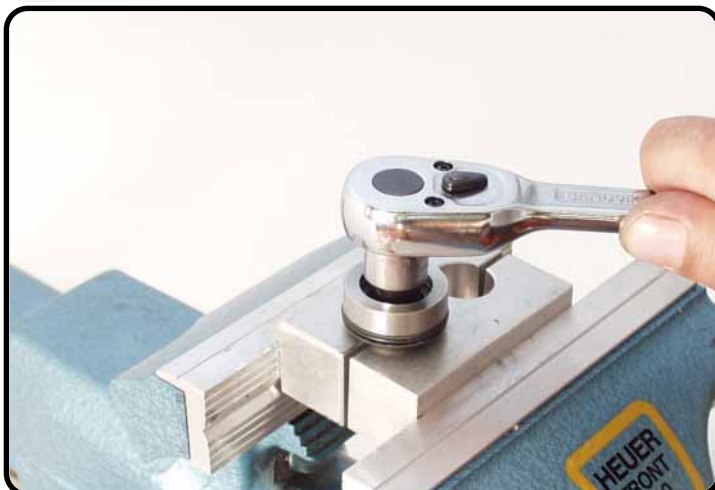

Unscrew the nut (size 10).



Turn the nut of.

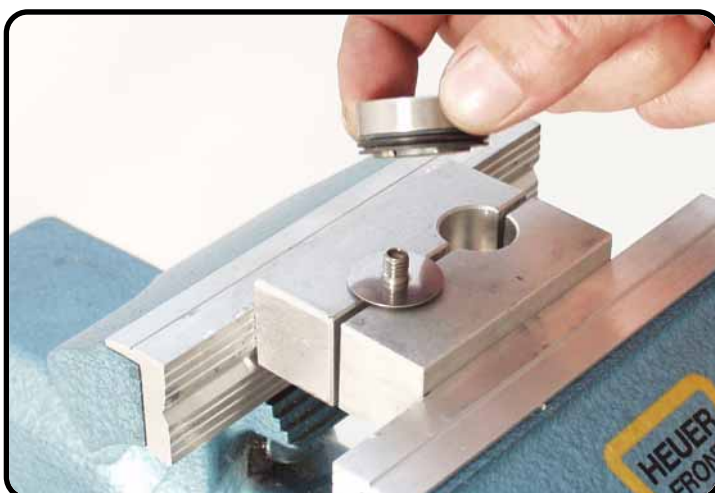

Remove the piston with check-valve.



Piston with the check-valve side.



Compression side.



Damping holder with shims (setting).



Remove the shims of the damping holder.
Pay attention to the assembling order and direction!!!



- Nut M6
- piston with check-valve
- setting (shims)
- damping holder
- disk.



Remove the O-ring of the screw-cap.



Turn clockwise the adjustment needle out of the screw-cap.



Adjustment needle "complete".

Workshop manual

5018 PDS 2003

Product

Exploded View

Disassembly & Assembling



- Steel ball
- spring
- adjustment needle with O-ring
- screw-cap
- O-ring

Assembling MCC

Assemble the spring and steel ball, and grease, also the O-ring, these with water proof grease T159.

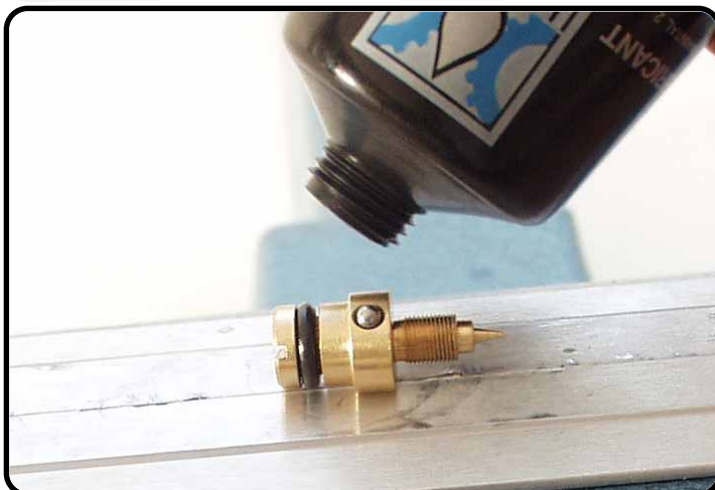

Assemble the O-ring.

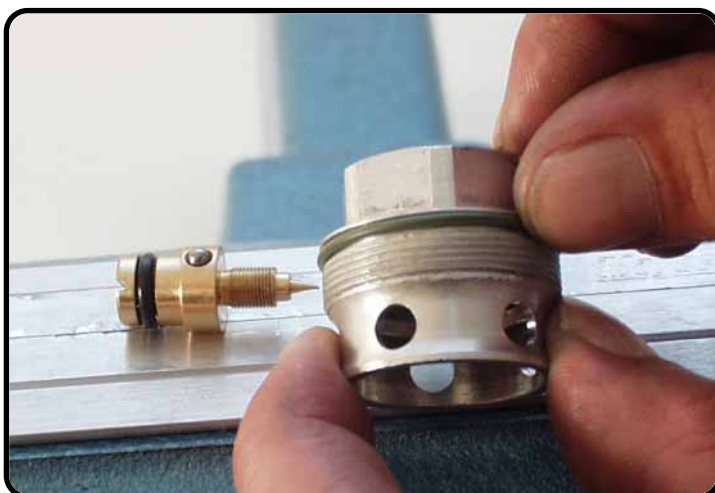

Assemble the needle.





Turn the needle fully open.



Replace the setting and piston with the check-valve

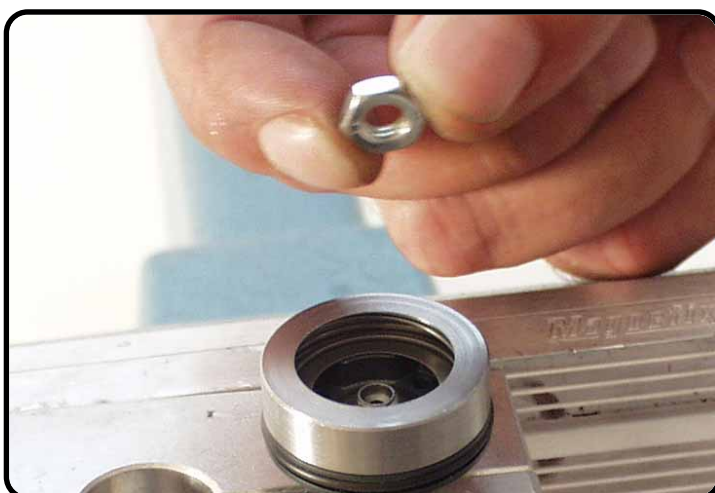

Wet the thread of the nut with Loctite 2701 (T132) and turn the nut on the holder.



Tighten the nut to a torque of 6Nm.



Replace the disk.

Assembling tube side

Assemble the O-ring on the bottom.



Assemble the O-ring inside the bottom.



Grease the O-ring groove of the separation piston with O-ring grease T158.





Assemble the O-ring.



Grease the O-ring with T158.

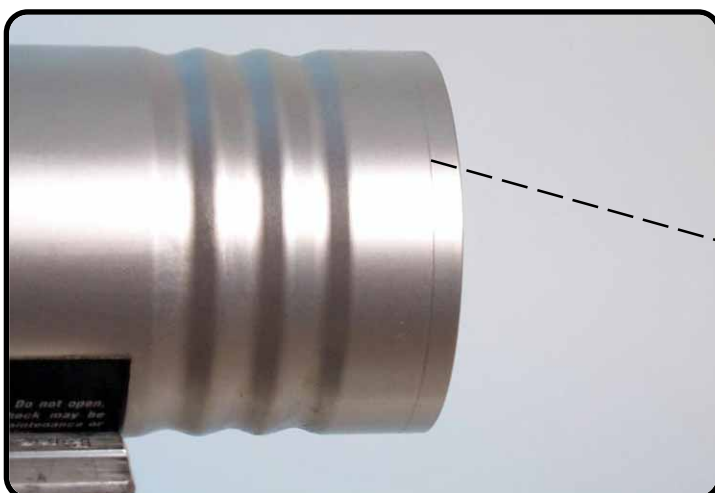

Pay attention to the groove of the nitrogen reservoir.

"groove".



1. Assemble the separation piston and piston ring with the hollow surface into the reservoir at the groove side.



2.



Push the separation piston into the reservoir.



Wet the thread of the bottom with T132.



Wet the thread of the reservoir with T132 on both sides.



Wet the thread of the screw-cap.



Turn the reservoir with screw-cap on the bottom.



Tighten the reservoir with T125S and T145S.



Wet the thread inside the bottom with T132.



Turn the lock retainer as far as possible onto the tube.

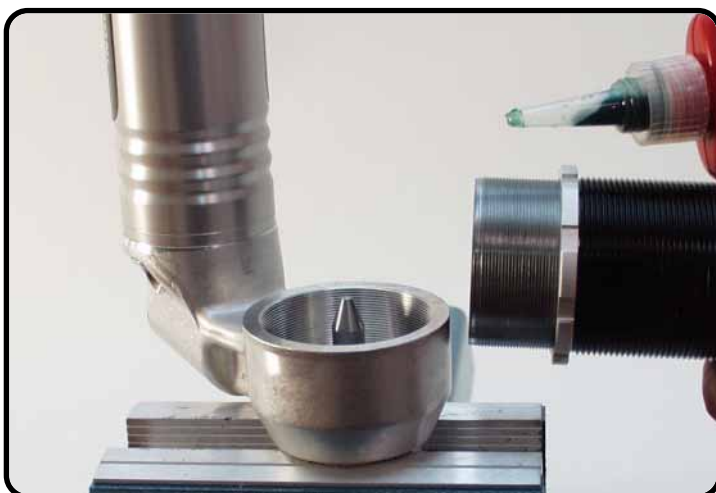

Wet the thread of the tube with T132.



Turn the tube into the bottom.



Tighten the tube with T146 and T1201.



Screw the lock retainer against the bottom and tighten it with T1233.



Turn the screw spring retainer onto the tube and...



...completely downwards.



Assemble the springring passed the groove of the tube.



Slide the spring guide onto the tube.



Assemble the first springring into the groove.



Slide the guiding bush over the springring.



Assemble the second springring.



Wet the O-ring of the piston MCC with T158.

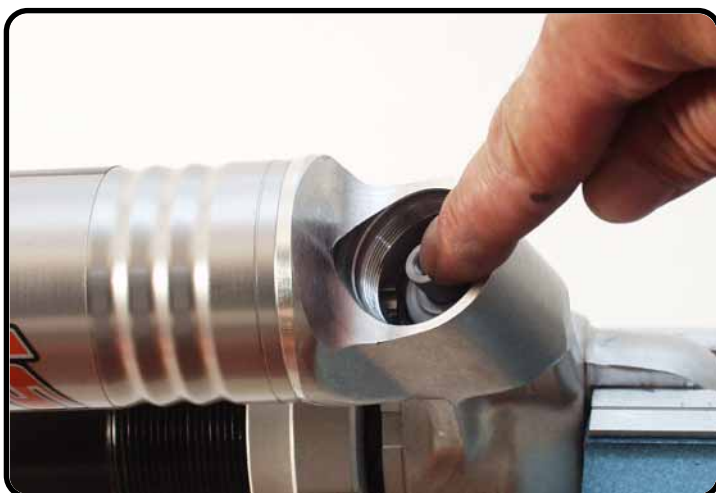

Assemble the damping holder MCC "cpl" into the housing of the bottom.

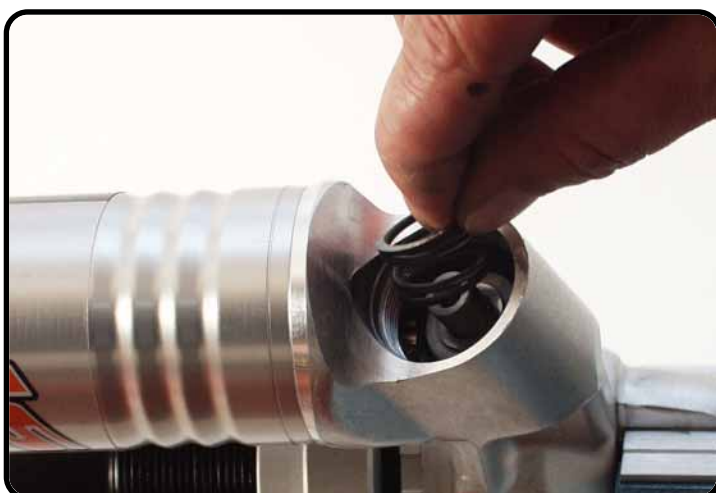

Assemble the spring.



Place the ring into the screw-cap.



Turn the screw-cap into the bottom.



Tighten the screw-cap.

Disassembly piston-rod side

Clamp the piston-rod "cpl" in the vice.



Unscrew the nut (size 22)





Turn off the nut.

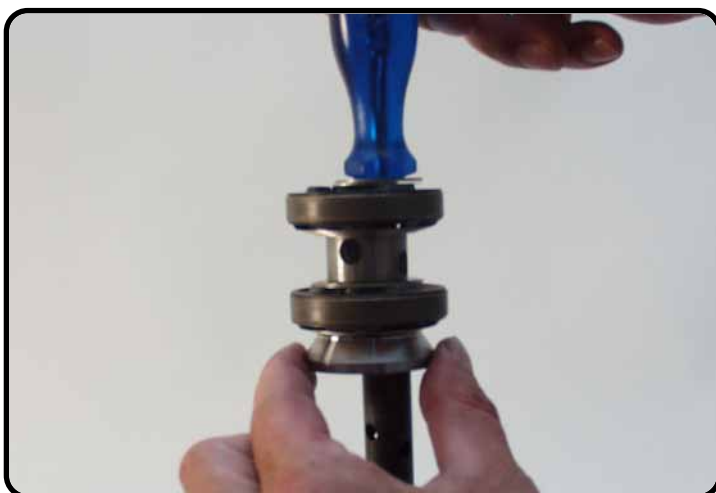

Place a screwdriver on top of the piston-rod and lift the entire assembly onto the screwdriver.



- Rebound bush plane
- compression setting 1 (shims)
- piston 1
- rebound setting 1 (shims)
- intermediate bush
- compression setting 2 (shims)
- piston 2
- rebound setting 2 (shims)
- piston-rod nut.



Remove the adaptor DU-bush.



Remove the cap.



Remove the bump rubber.



Clamp the mounting-fork in the vice.



Unscrew the screw-cap of the rebound adjustment (size 15).



Turn the screw-cap out of the mounting-fork.

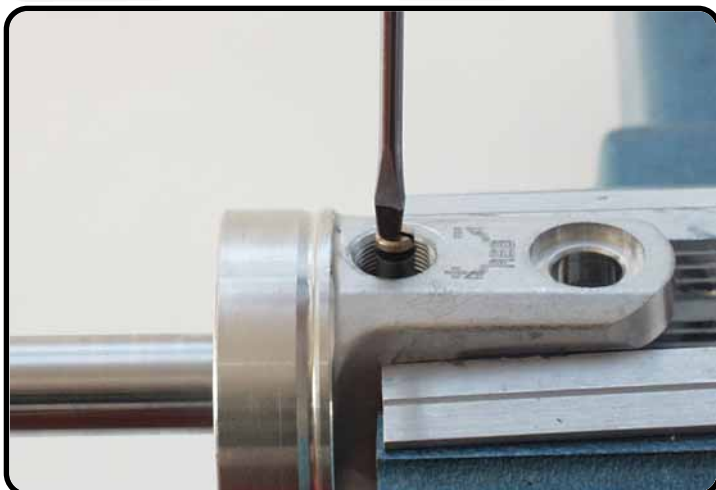

1. Turn the rebound adjustment needle anti clockwise out of the mounting-fork.

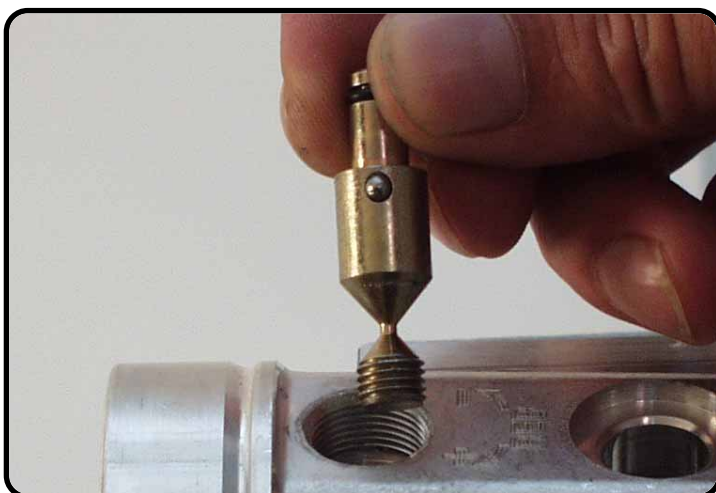

2.



Rebound adjustment needle with the screw-cap.



1. Push the rubber plug out of the mounting-fork.

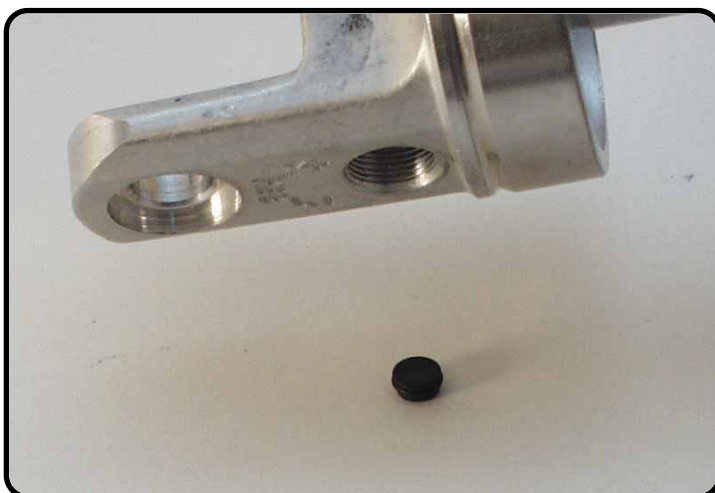

2.



Push with an pin (d2) on top of the piston-rod the rebound needle out of the piston-rod.

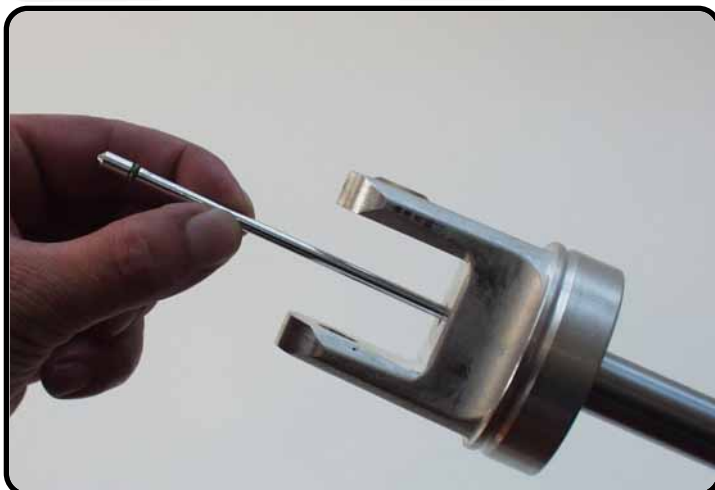

Take the rebound needle out.



Rebound needle.

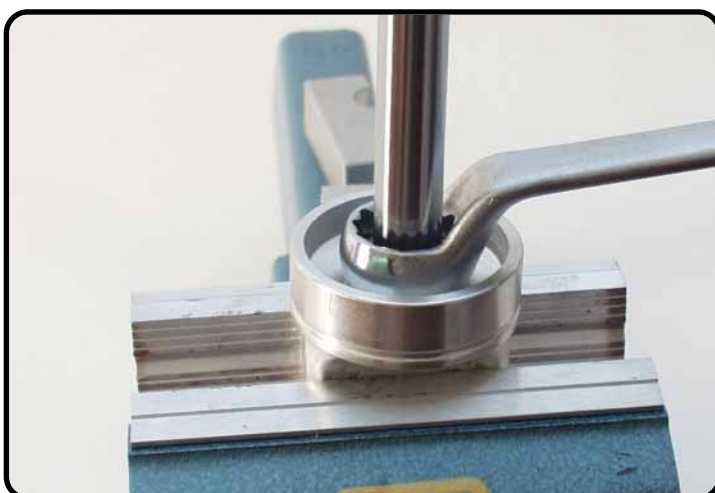

Clamp the mounting-fork in the vice and unscrew the locking nut (size 24).



Clamp the piston-rod in clamping block T1202S.



Heat de mounting-fork.



Unscrew the mounting-fork.



Turn the mounting-fork of the piston-rod.



Turn the nut of the piston-rod.



Push with een Allenkey (size 5) the rebound tube out of the piston-rod.

Workshop manual

5018 PDS 2003

Product

Exploded View

Disassembly & Assembling



Piston-rod and rebound tube "cpl".

05/2002

Shock absorber 5018 PDS 2003



Disassembly adaptor DU-bush

Adaptor DU-bush.



1. Lift the rebound spring out of the adaptor.

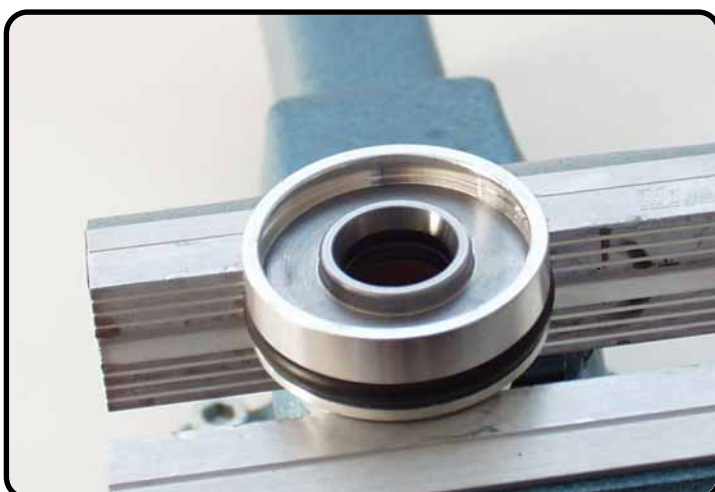

2.



Remove the steel washer.
Pay attention to the back-up ring in the washer.



Remove the quad ring.



Remove the second back-up ring.



Lift the dirt scraper out of the adaptor.



Disassemble the O-ring.



Dis- / assembling tool T1504, adaptor and support bush T1209.

Workshop manual

5018 PDS 2003

Product

Exploded View

Disassembly & Assembling

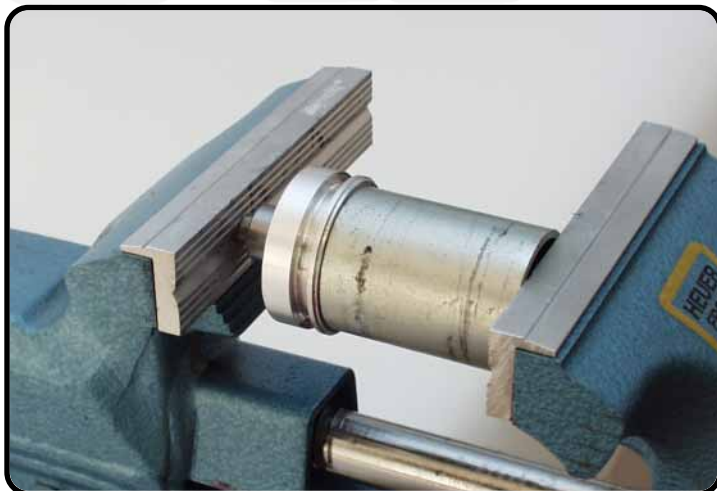

Press the DU-bush out of the adaptor.

05/2002

Shock absorber 5018 PDS 2003



Assembling adaptor DU-bush

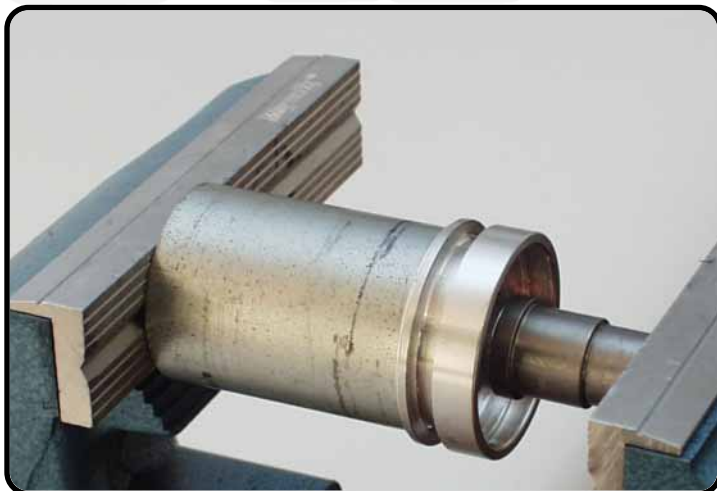

Press the DU-bush into the adaptor with T1504 and T1209.

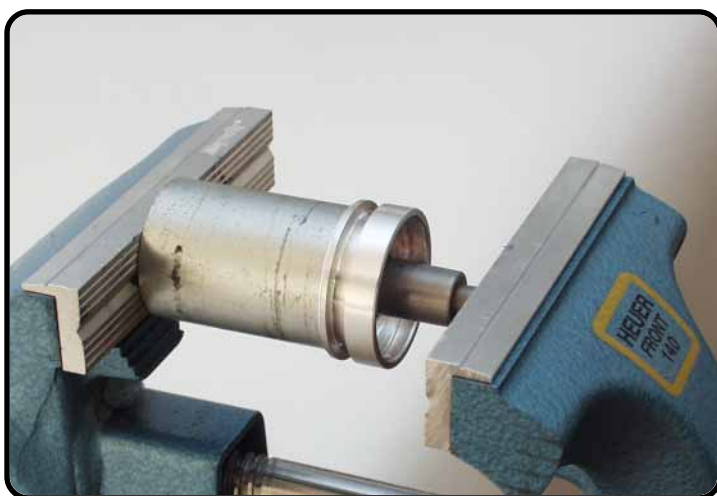

Calibrate the DU-bush with the calibration thorn T1205.

Important: wet the thorn with oil before the calibration.

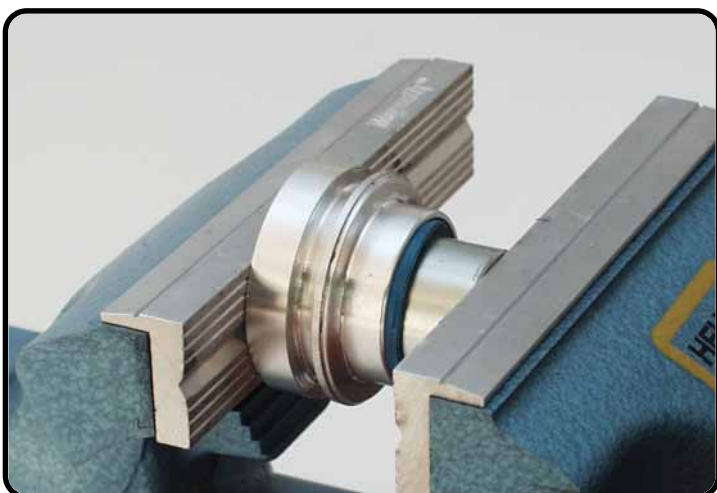

Press the dirt scraper into the adaptor with assembling bush T1204.

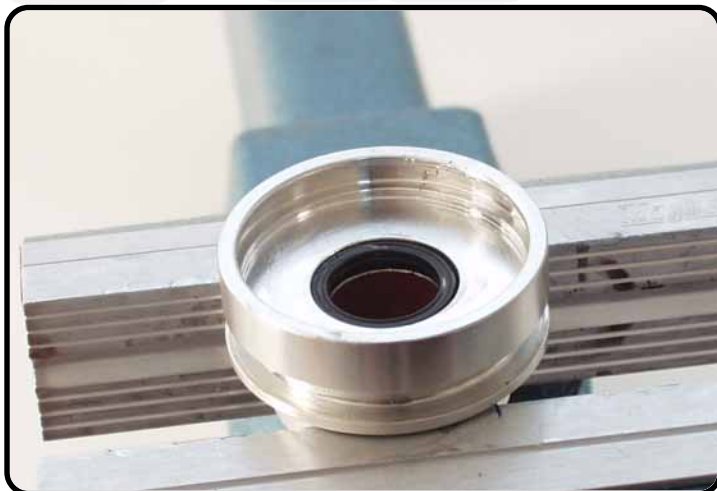

Assemble the first the back-up ring and then the quad ring into the adaptor.



Replace the steel disk with the back-up ring.



Assemble the rebound spring with support of T1209.



Assemble the O-ring.

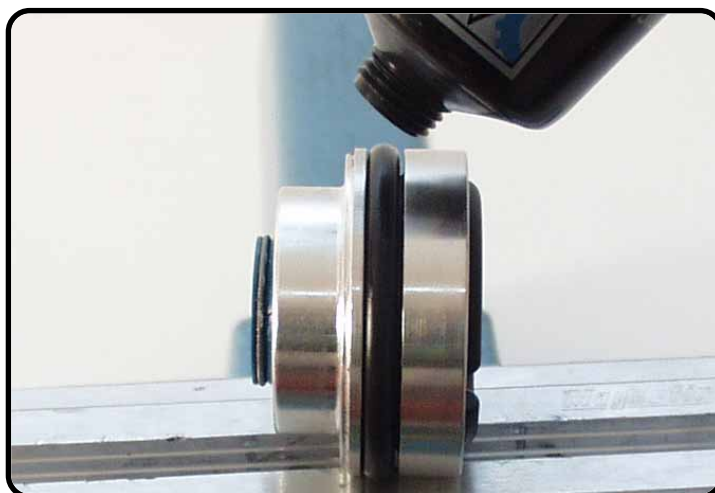

Grease the O-ring with T158.

Assembling piston-rod side

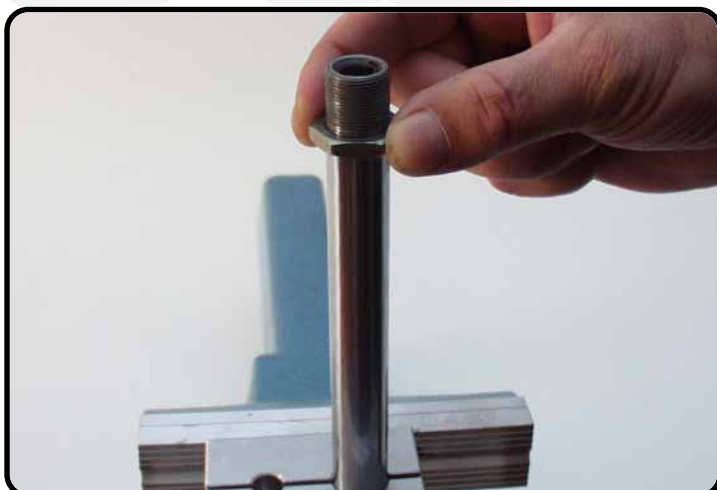

Turn the lock nut on the piston-rod.



Grease the O-ring of the rebound tube with T158.



Assemble the tube into the piston-rod.



Wet the thread of the piston-rod with T132.



Turn the mounting-fork on the piston-rod.



Tighten the mounting-fork.



Turn the lock nut against the mounting-fork.



Tighten the nut.



1. Place assembling tool T1215 on top of the piston-rod.



2.



Assemble the bump rubber.

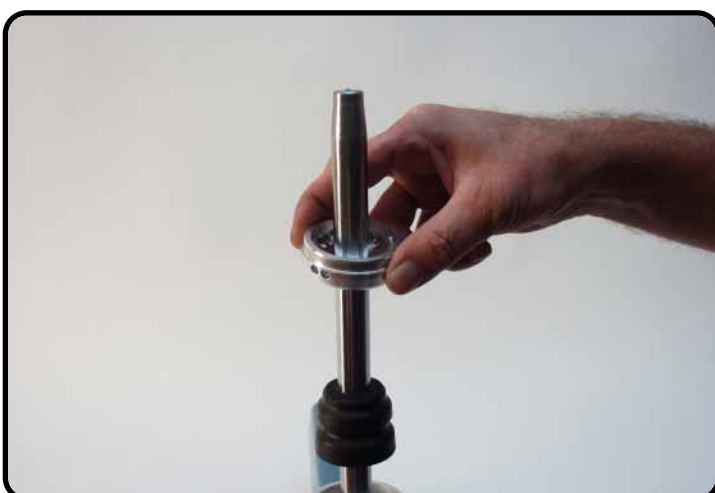

Replace the cap.



Replace carefully the adaptor DU-bush.



Replace the entire damping package.



Pay attention to the first shim, this one must be centered on the ring.

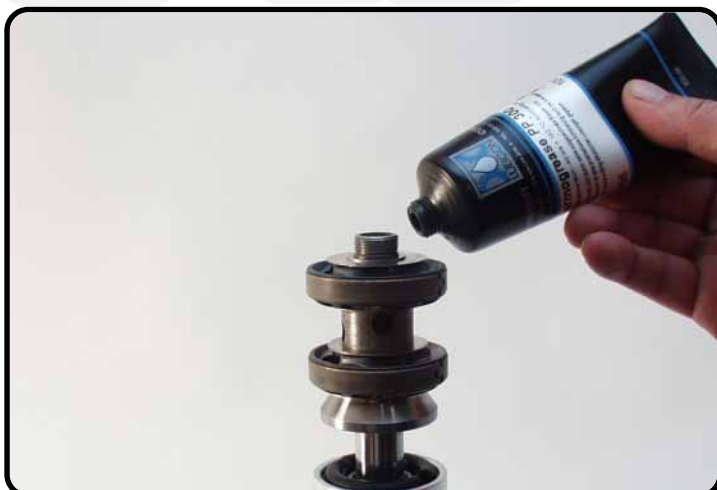

Grease the thread of the piston-rod with a little bit of T158.



Turn the nut on the piston-rod.



Turn the nut just so far so that the pistons can still be turned.



Place the center sleeve T1214...



...over both pistons and adaptor
DU-bush.



Place T107S through T1214,
intermediate bush and piston rod.



Tighten the piston-rod nut to a torque of 40Nm.



Check if you can lift the shim.



Grease the O-ring of the rebound needle with T158.

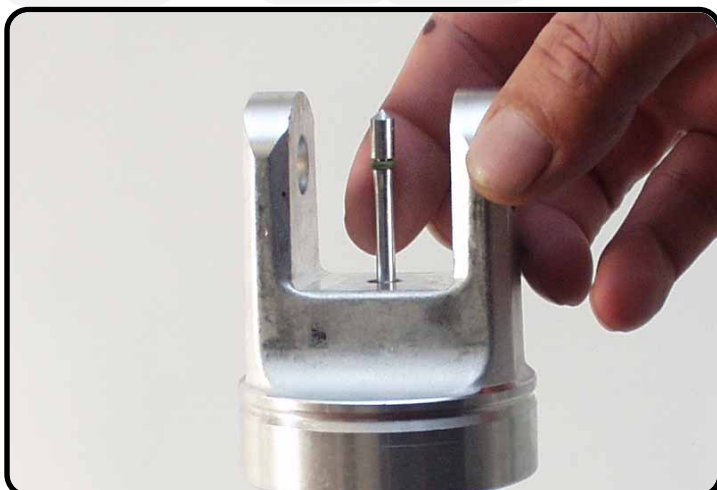

Assemble the needle into the piston-rod.



Push the needle further.



Grease the O-ring and steel ball of the rebound adjustment needle with T159.

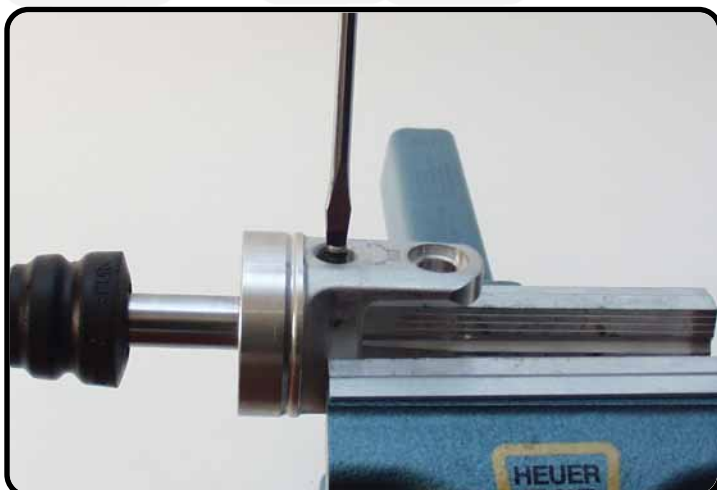

Screw the adjustment needle into the mounting-fork.

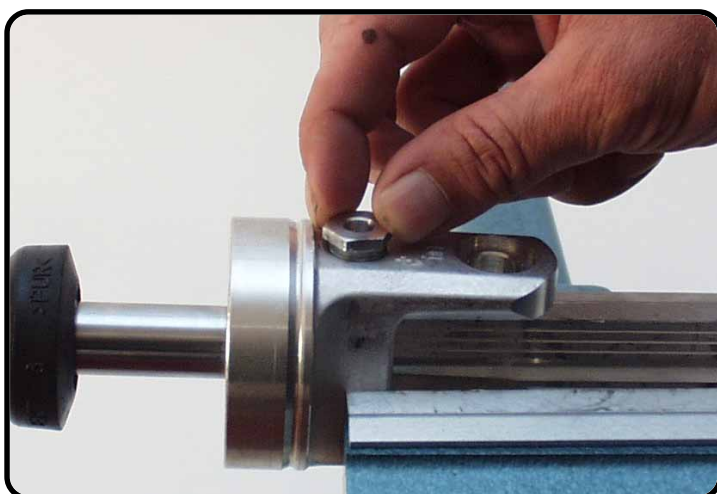

Turn de rebound screw-cap into the mounting-fork.

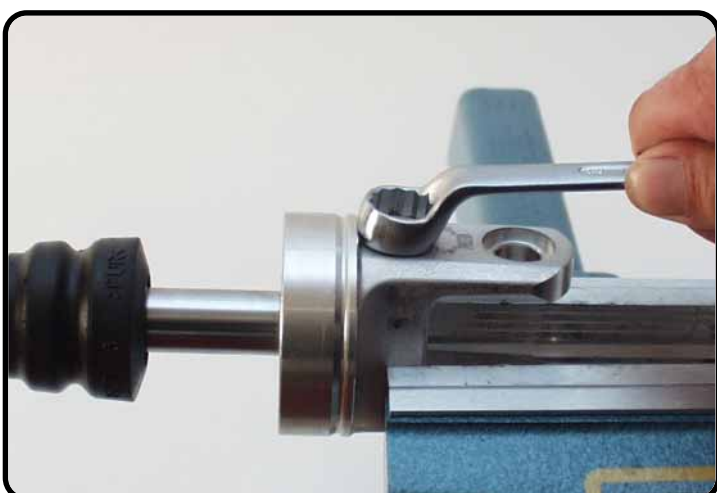

Tighten the screw-cap.

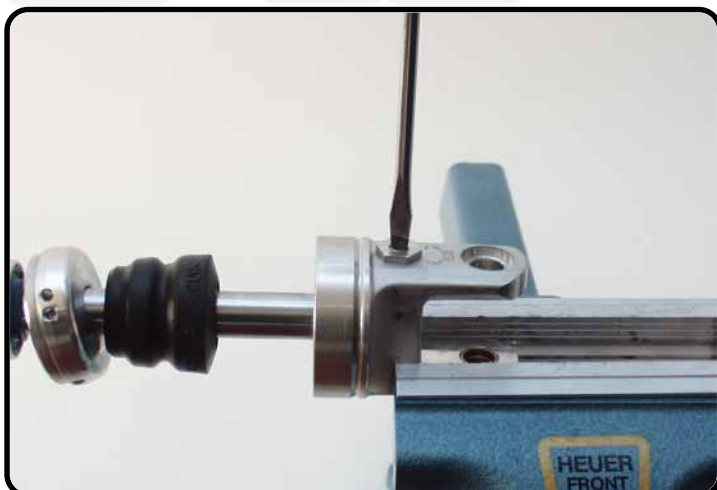

Turn the adjustment completely open.



Push the needle downwards.

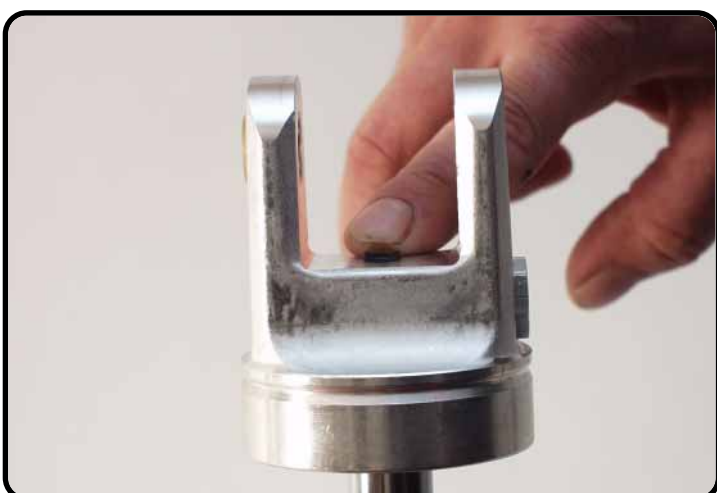

Assemble the rubber plug.

Assembling shock absorber



Turn the compression adjustment fully open. (DCC High and Low-speed)



Fill the tube with oil, just under the springing groove inside the tube.



Place plunger T1210S into the tube.



Push the plunger downwards.



Push with T107S the separation piston in the reservoir as far as possible.



Slide the O-ring of T107S against the screw-cap.



Push again with T1210S.



Push with T107S the separation piston...



...to the correct position, the O-ring of T107S must have a distance of about 10mm from the screw-cap.



Fill oil till 10mm under the groove.



Close the compression adjustment.
(DCC Low-speed)

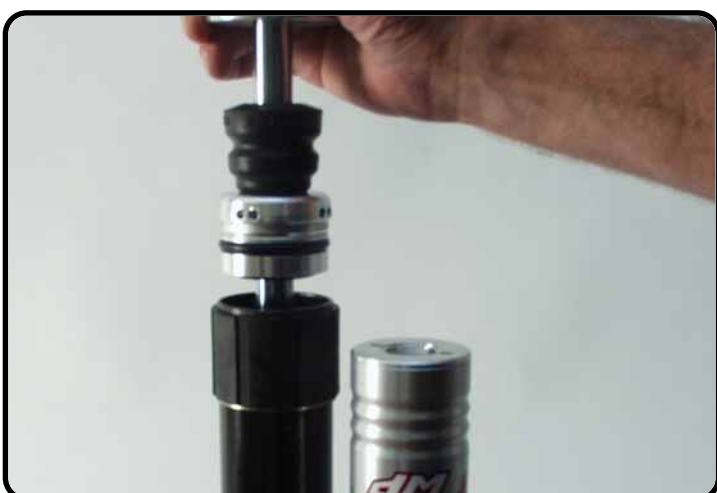

Push both pistons under the oil.



Open the compression adjustment.



Push the adaptor DU-bush just under the O-ring groove.



Assemble the springring.



Pull the piston-rod fully out.



Tap the cap into the tube.

Bleeding

Clamp "not too tight" the shock absorber in the vice like picture.



1. Unscrew the screw-cap and remove the entire MCC.



2.





Turn adaptor T1502S of the air release bottle T144S into the MCC (DCC) housing of the bottom.



Ensure that there is sufficient oil in the bottle.



Hold the bottle up so that the oil will flow into the shock absorber.



Push the piston rod slowly completely inwards.



And out.
Repeat those handlings several times.



Can't the shock absorber several times.



Repeat all the handling till all air is out of the shock absorber.



Push the separation piston to the correct position.



Remove the adaptor.



Assemble the MCC (DCC).

On pressure with nitrogen



Turn the nitrogen plug with O-ring several turns into the screw-cap of the reservoir



Nitrogen charging device T170S.



Place the shock absorber in T170S and open de tap for about 20 seconds.



Close the nitrogen plug.



Close the tap.

Workshop manual

5018 PDS 2003

Product

Exploded View

Disassembly & Assembling



Assemble the rubber cap.

05/2002

Shock absorber 5018 PDS 2003



Assembling spring

Assemble the washer.



Assemble the spring.





Assemble the second washer.



Assemble the spring retainer.



Assemble the springring.



Adjust the spring...



...to the correct preload.



Tighten the bolt to a torque of 5Nm.

Adjustment

Turn the mounting-fork to the correct position.

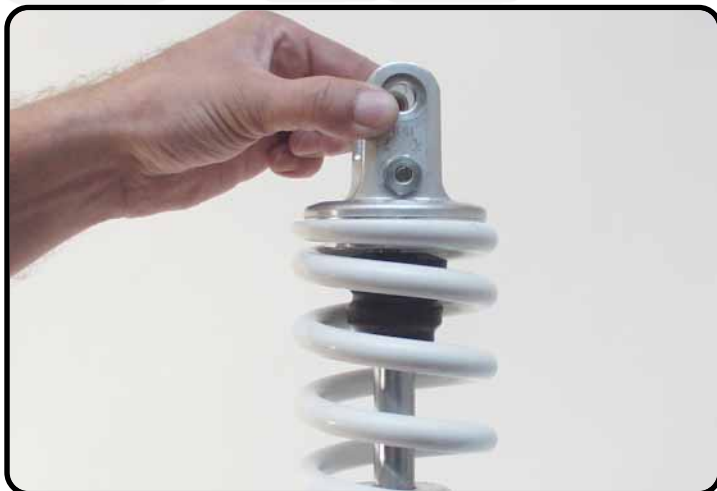

Compression position (MCC)!



Compression Low-speed position (DCC)!





Compression High-Speed position (DCC)!



Rebound position!